

TOWN OF KNIGHTDALE STANDARD SEDIMENT AND EROSION CONTROL PLAN FOR SINGLE FAMILY LOTS

Table of Contents	
STANDARD SEDIMENT AND EROSION CONTROL PLAN	A-1
TYPICAL INDIVIDUAL LOT SEDIMENT & EROSION CONTROL MEASURES DETAILS	A-2
LOT NUMBERS, DISTURBED ACREAGE & DRAINAGE PATTERN TYPE TABLE	A-3
STANDARD TEMPORARY SILT FENCE DETAIL	A-4
STANDARD TEMPORARY SILT FENCE OUTLET DETAIL	A-5
STANDARD RESIDENTIAL CONSTRUCTION ENTRANCE DETAIL	A-6
STANDARD INLET PROTECTION DETAIL	A-7
STANDARD CHECK DAM DETAIL	A-8
STANDARD WATTLE DETAIL	A-9
ROLLED EROSION CONTROL PRODUCT INSTALLATION DETAIL	A-10
STANDARD TREE PROTECTION FENCE DETAIL	A-11
NCG01 GROUND STABILIZATION AND MATERIALS HANDLING	A-12
NCG01 SELF INSPECTION, RECORDKEEPING AND REPORTING	A-13
SEEDING REQUIRMENTS	A-14
OTHER NOTES, REFERENCES AND ACKNOWLEDGEMENTS	A-15

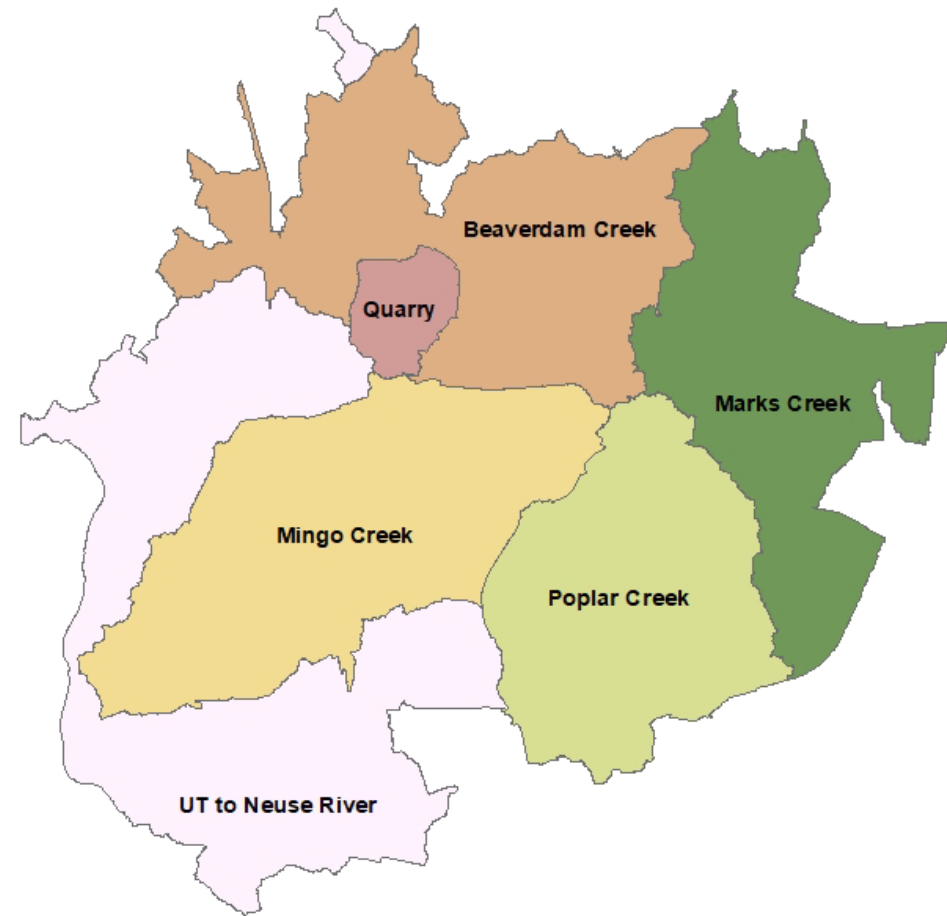

PROJECT NAME: _____

TOK Project Number: _____

DATE OF PERMIT ISSUANCE: _____

DATE OF PERMIT EXPIRATION: _____

NOTE – ANY PERFORMANCE RESERVATIONS REGARDING THE SEDIMENT CONTROL PLAN (PERFORMANCE BASED) OR CRITICAL AREAS, A FIELD REVISION OR AN ENGINEER STAMPED CUSTOM PLAN MAY BE REQUESTED.

TYPICAL CONSTRUCTION SEQUENCE FOR SINGLE FAMILY LOTS SEDIMENT AND EROSION CONTROL

1. This standard plan is for lots with a disturbed area of less than 1 acre and a total site disturbance less than 5 acres. If the disturbed area is greater than 1 acre (on a single lot or multiple lots that are mass graded) a custom erosion control plan must be prepared and submitted online for the 30-day review cycle and pay the erosion control plan review and grading permit fees.
2. This standard plan is for lots that are "finished, pad ready", or at final grade. Mass grading with full stabilization has already occurred or mass grading will not occur.
3. The standard plan is not for sites located in a High Quality Water (HQW) Zone and properties that contain jurisdictional wetlands or streams within 100 feet of the lots.
4. Town of Knightdale reserves the right to require a site-specific erosion control plan to be prepared and submitted for the 30-day review cycle.
5. As of April 1, 2019 applicants must apply online for NCG-01 Permit coverage from NCDEQ. This requirement is in addition to the Town of Knightdale land disturbance permit.
6. Obtain all necessary permits and certificates. Download standard sediment and erosion control plan for single family lots from www.knightdalenc.gov.
7. Schedule onsite pre-construction meeting with Town of Knightdale Construction Inspector
8. Install tree protection fence if required. Install gravel construction entrance, silt fence, silt fence outlets and additional measures as needed. Clear only as necessary to install devices. Provide groundcover for all disturbed areas.
9. Schedule "Initial Perimeter Control Inspection" in Wake County Permit Portal to obtain a Certificate of Compliance for each lot.
10. Begin construction, building, clearing and grubbing. Maintain erosion control devices as needed.
11. Stabilize site as areas are brought up to finish grade with vegetation, paving, ditch linings, etc. Provide groundcover for denuded areas per NPDES Ground Stabilization Timeframes.
12. When construction is complete, and all areas are permanently stabilized and erosion control measures are removed, Schedule "Final Site Stabilization" inspection in Wake County Permit Portal.
13. Obtain a Certificate of Completion

KNIGHTDALE
stormwater

EFFECTIVE: 05/16/2022

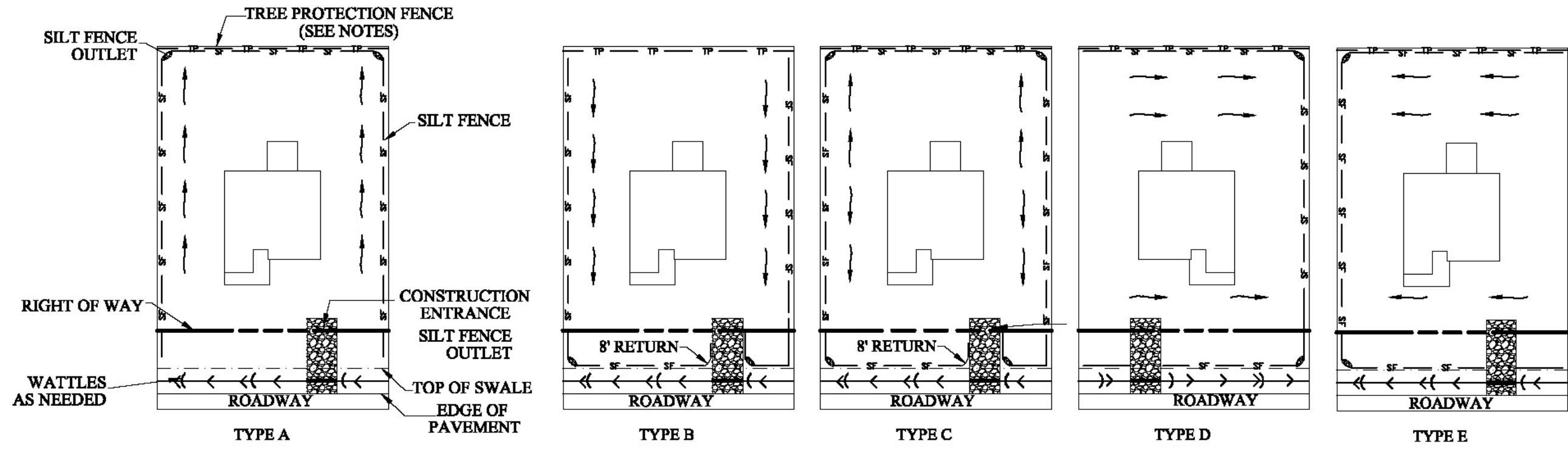

NOTES:

LEGENDS

- FLOW DIRECTION
- SF — SILT FENCE
- → DIVERSION DITCH
- (WATTLES
- TP — TREE PROTECTION FENCE
- SILT FENCE OUTLET
- (WATTLES
- DRAINAGE PIPE
- ▨ CONSTRUCTION ENTRANCE

1. Tree protection fencing should be installed along the rear of the property line when adjacent to riparian buffer zones, wetlands and/or 25ft. Tree and Vegetation Protection Zone.
 2. Install silt fence on low elevation sides of each lot and install silt fence outlets should on schematic diagram and as needed.
 3. Install silt fence within 10 feet of property line on all sides of lot to avoid conflict with septic system. It is the responsibility of the builder to avoid septic system conflict with silt fence installation.
 4. Construction entrance should be installed for each lot and filed located.
 5. These details are only for lots with disturbed acre less than one acre.
 6. If the disturbed acre is greater than one acre, a custom erosion control plan should be submitted for the 30-day review cycle. The plan should address berms/diversions and sediment traps and basins.
 7. If multiple lots share silt fence with none installed between the lots, a revised plan will be required and a Notice of Violation (NOV) will be issued.
 8. Inlets downstream of disturbances should be protected, streets should be swept as needed when sediment is present, and erosion control measures removed or damaged by sub-contractors or utilities shall be re-installed at the end of the workday.
 9. Details for silt fence, silt fence outlet, construction entrance and other measures are provided on other sheets.
 10. Erosion control details are not drawn to scale.
 11. Verify the land disturbance does not impact septic field or repair field as this may void on-site wastewater permit validity.
 12. If lots are contiguous and have different landowners, lots cannot share silt fences. Each lot should have individual silt fences.
- Standard erosion control plan does not cover the following:
- a) Basement lots
 - b) Lots with greater than 5 feet elevation between the tow of slope and/or lots with greater than 10 feet elevation of the disturbed area from front to back.
 - c) Lots with concentrated flow/swales between them
 - d) Lots with Stormwater Control Measures (SCMs) for the individual lot
 - e) Lots receiving offsite concentrated stormwater



TYPICAL INDIVIDUAL LOT SEDIMENT & EROSION CONTROL MEASURES DETAIL

LOT NO.	PARCEL PIN	ADDRESS	DISTURBED ACREAGE (ACRES)	DRAINAGE PATTERN TYPE	NOTES

Please attach an Individual Lot Table like the one shown above.

This table should include the following information for each lot included in the submittal.

- Lot Number
- Parcel PIN
- Address
- Disturbed Acreage (acres)
- Drainage Pattern Type
- Notes



LOT NOS., DISTURBED ACREAGE AND DRAINAGE PATTERN TYPE TABLE
(ADD MORE TABLE(S) IF NECESSARY)

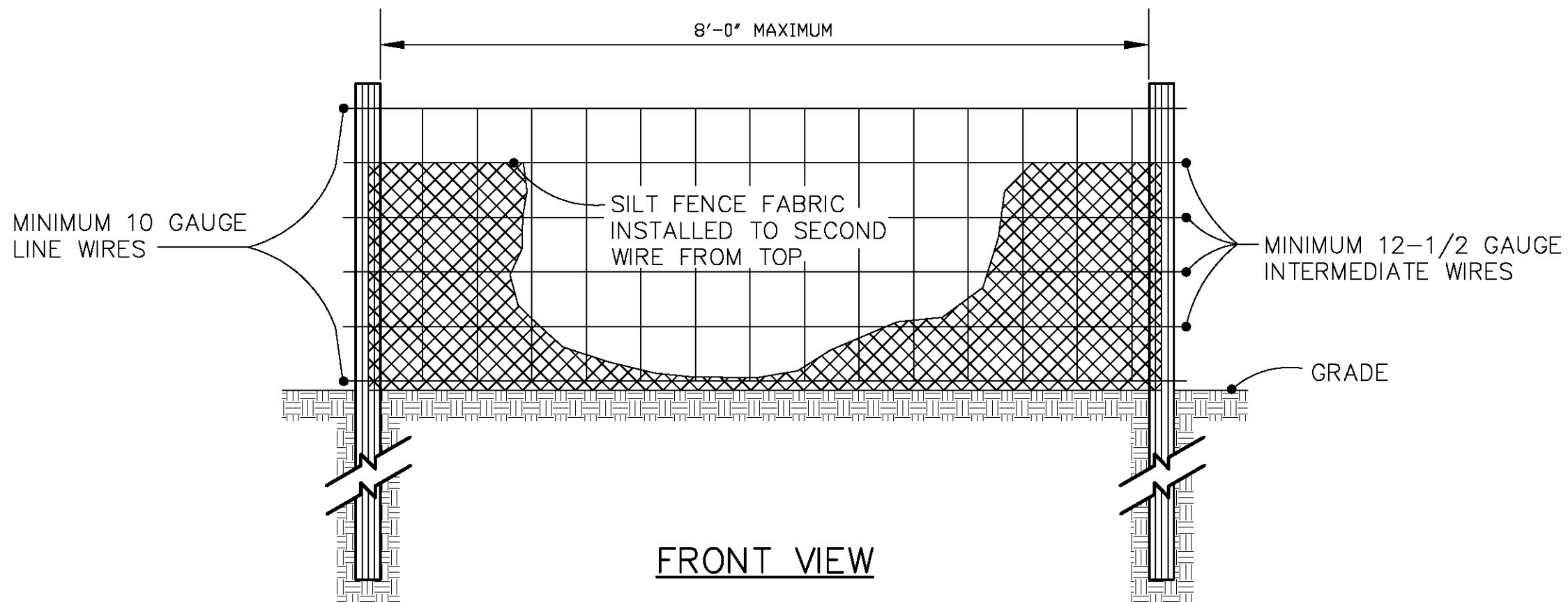

FRONT VIEW

NOTES:

1. Use silt fence only when drainage area does not exceed 1/4 acre and never in areas of concentrated flow.
2. Remove deposited sediment when 50% capacity is reached and as needed to provide storage volume for the next rain event and to remove hydraulic pressure on the silt fence.
3. Inspect silt fence weekly and after each 1" rain event.

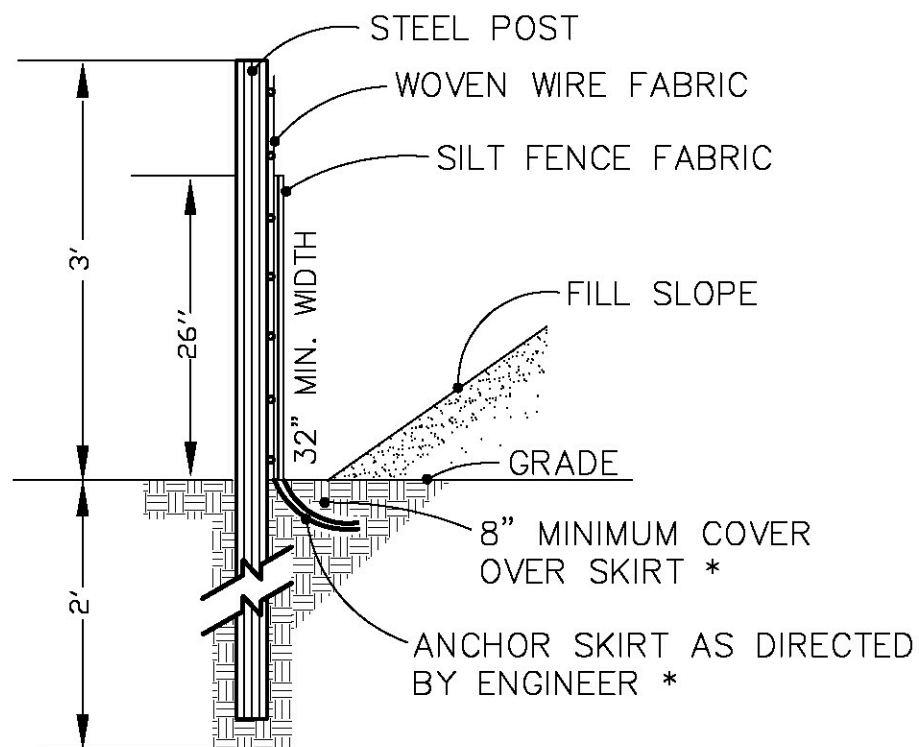

SIDE VIEW



STANDARD TEMPORARY SILT FENCE DETAIL

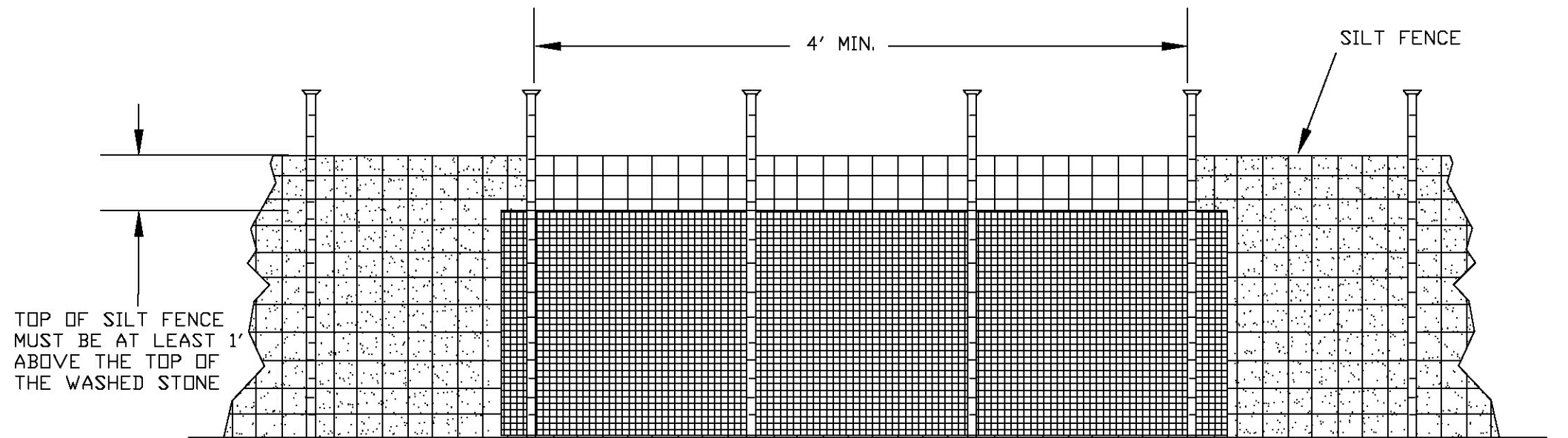

NOTES:

1. Remove sediment when half of stone outlet is covered.
2. Replace stone as needed to facilitate dewatering.
3. Stone outlets should be placed on low elevation areas of silt fence and based on field conditions.
4. Per NCG-01, inspect outlet at least once a week and after each 1" rain event. Complete any required repairs immediately. Freshen stone when sediment accumulation exceeds 6 inches. Keep mesh free of debris to provide adequate flow.
5. Hardware cloth and gravel should overlap the silt fence at least 12 inches.

FRONT VIEW

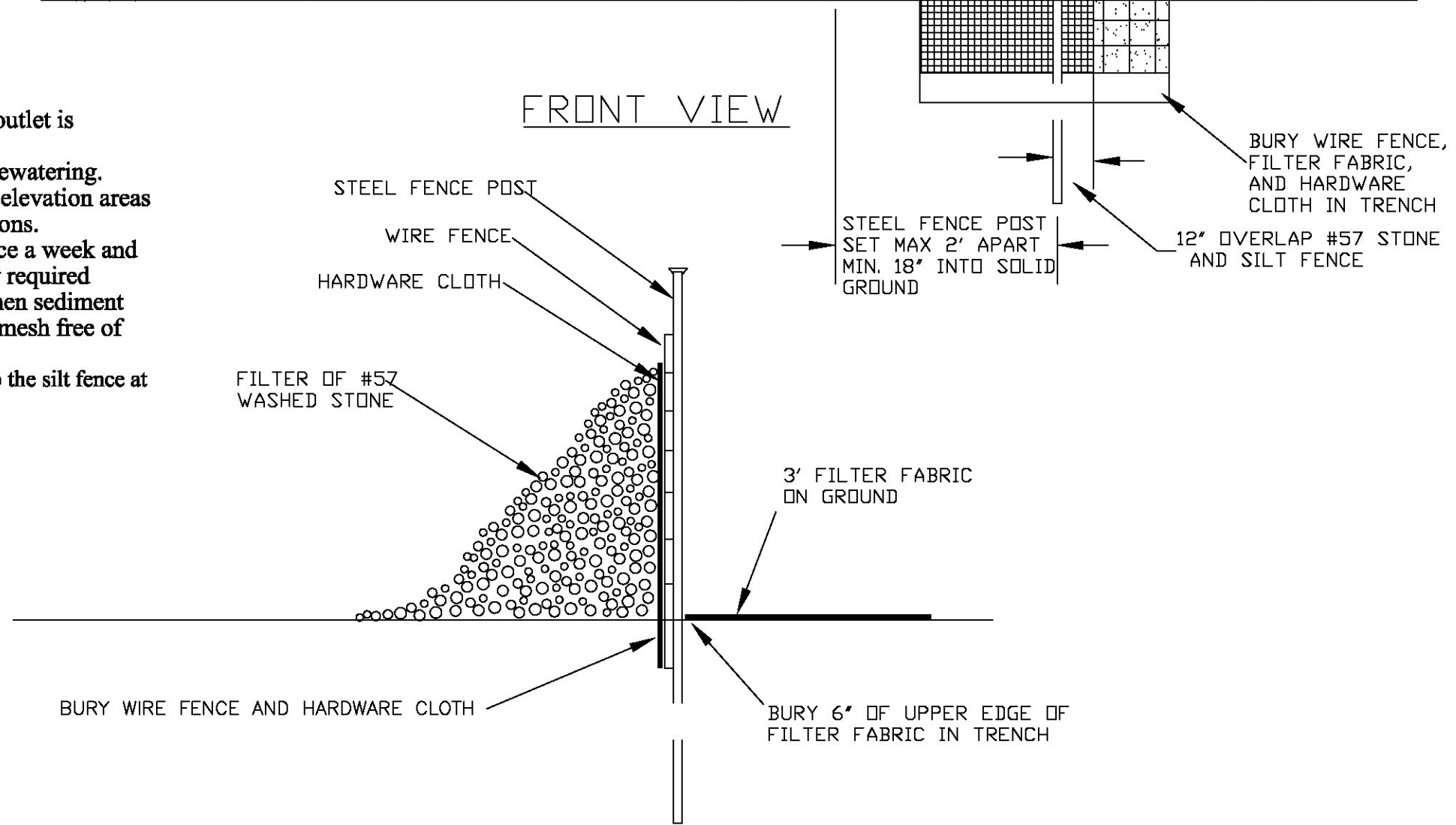

SECTION VIEW



STANDARD TEMPORARY SILT FENCE OUTLET DETAIL

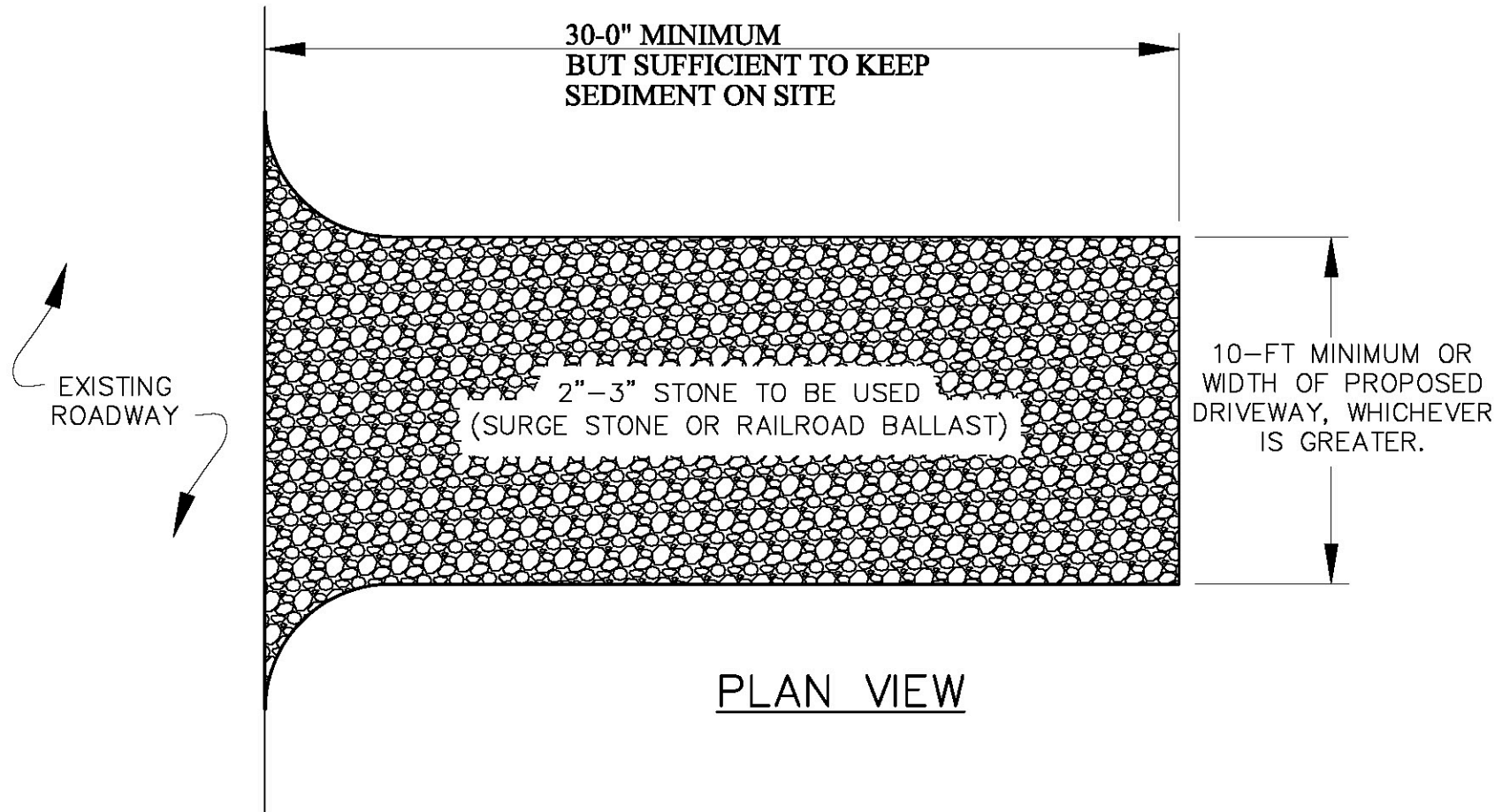

PLAN VIEW

NOTES:

1. Install silt fence or tree protection fence adjacent to construction entrance to direct vehicles to drive on stone.
2. If mud is not removed from the vehicles traveling over the stone, then the tires of the vehicles should be washed before entering the public road or the construction entrance must be lengthened. Sweep streets immediately if mud is tracked offsite onto public roads.
3. Maintain construction entrance in a condition to prevent mud or sediment from leaving the site. Entrance will require periodic removal of sediment-laden stone and replacement with fresh stone. Immediately remove all mud/sediment/rock tracked off the lot.

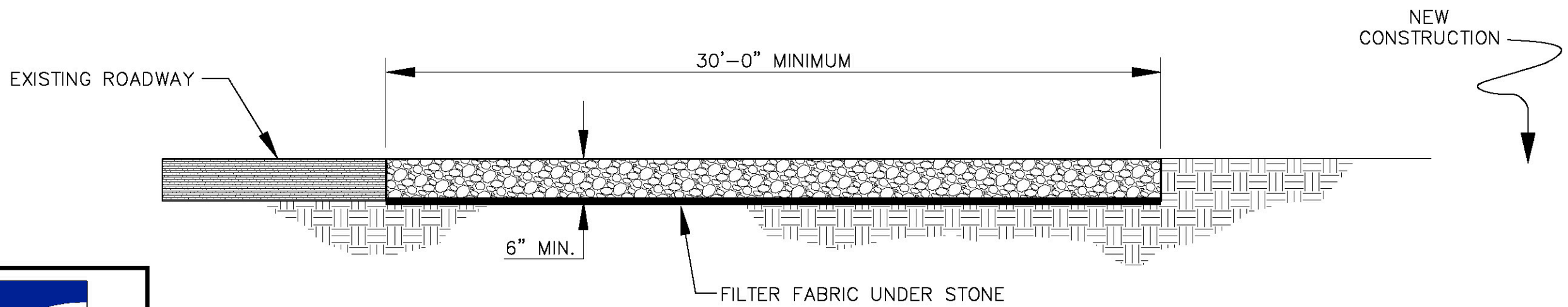

CROSS SECTION



STANDARD RESIDENTIAL CONSTRUCTION ENTRANCE DETAIL

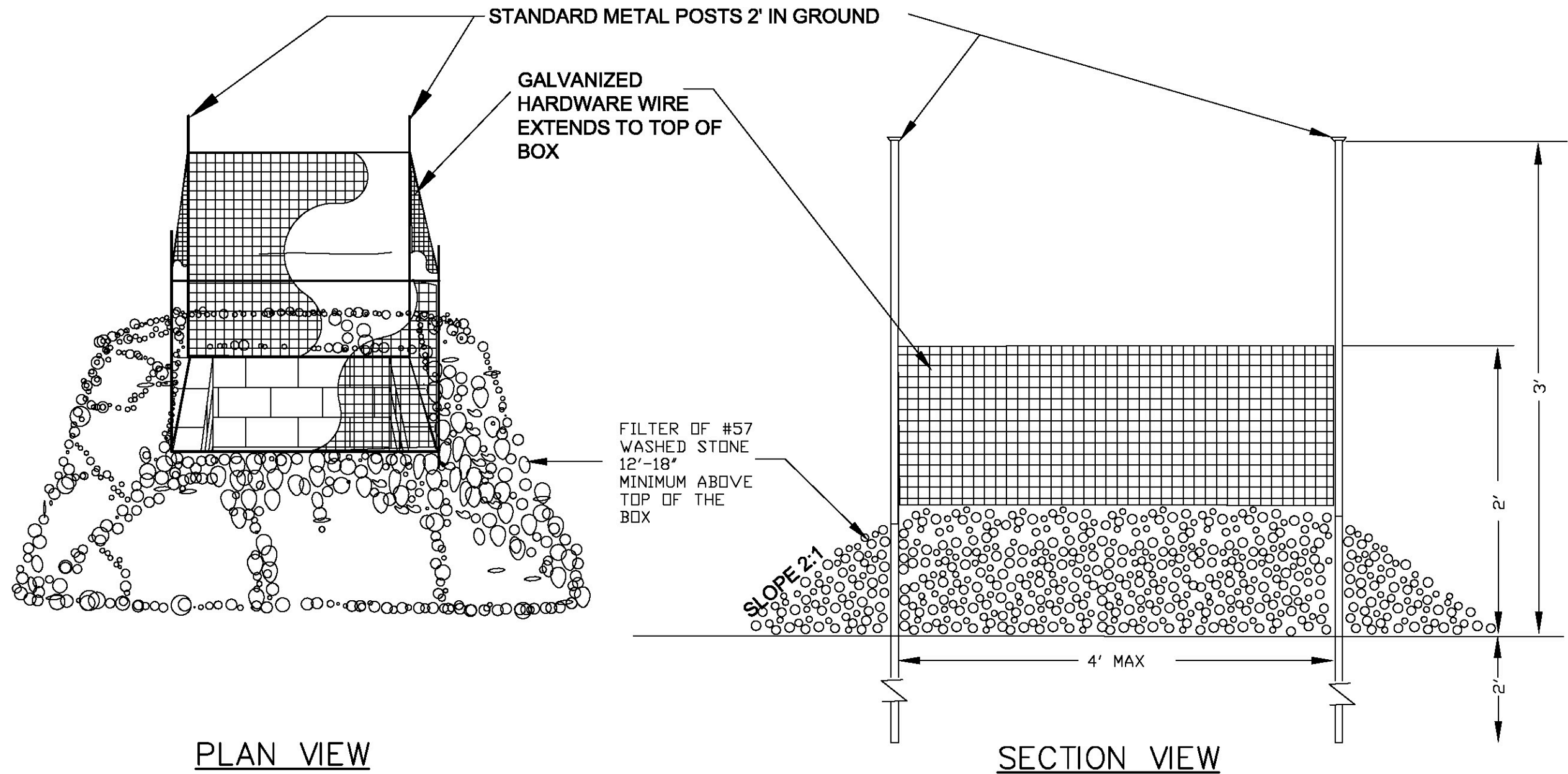

PLAN VIEW

SECTION VIEW

NOTES:

Inlet protection will require periodic removal of sediment-laden stone and replacement with fresh stone. Inspect periodically and replace stone as needed. Keep mesh free of debris to provide adequate flow.



EFFECTIVE: 4/15/19

STANDARD INLET PROTECTION DETAIL

A-7

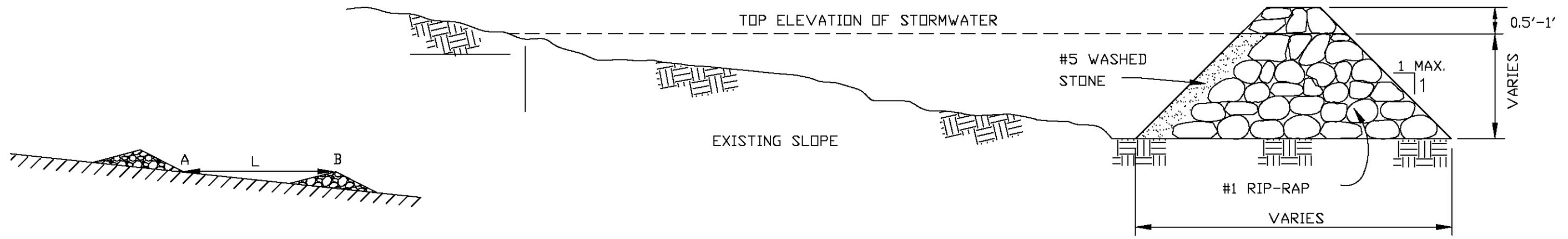

SIDE VIEW

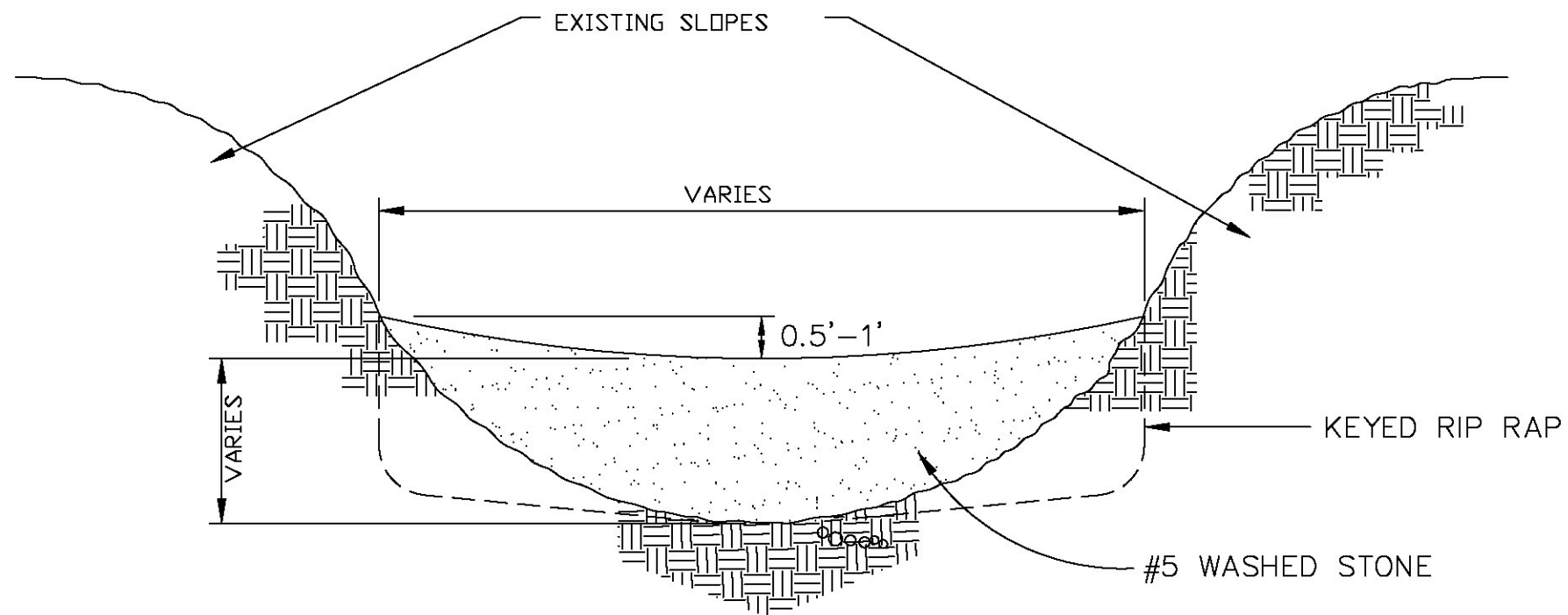

FRONT VIEW

NOTES:

1. Check dams are used in channels to reduce erosion in drainage ditches.
2. Height and width of the check dams are determined by existing topography and sediment storage requirement.
3. Set spacing between check dams so that the elevation at the top of the lower dam is the same as the toe elevation of the upper dam.
4. Wattles may be used in lieu of check dams if they are installed and maintained as per manufacture's specification. Wattle diameter should be specified based on channel cross section.
5. Inspect check dams at least once a week and after each rain event. Complete any required repairs immediately. Remove sediment accumulation from behind check dams to prevent damage to the channel vegetation. Flow should be maintained through the dam.



EFFECTIVE: 4/15/19

STANDARD CHECK DAM DETAIL

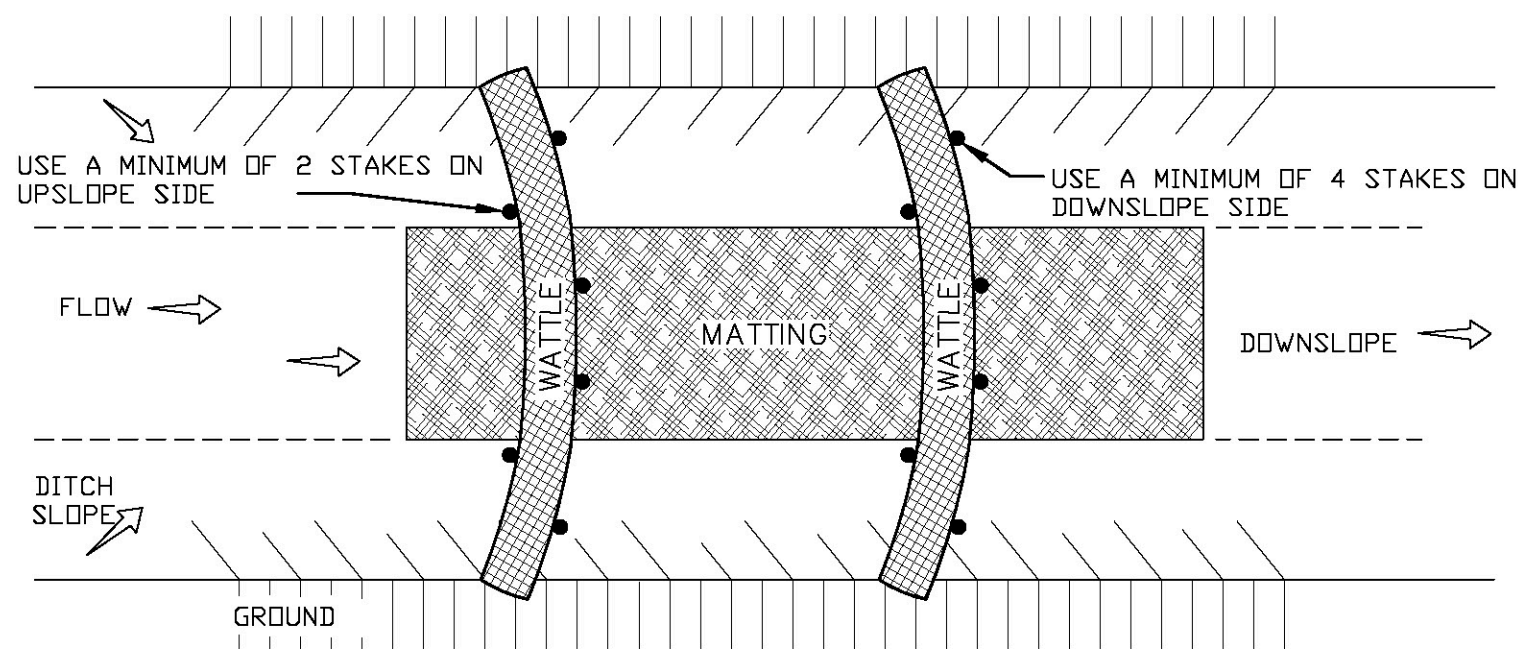

PLAN VIEW

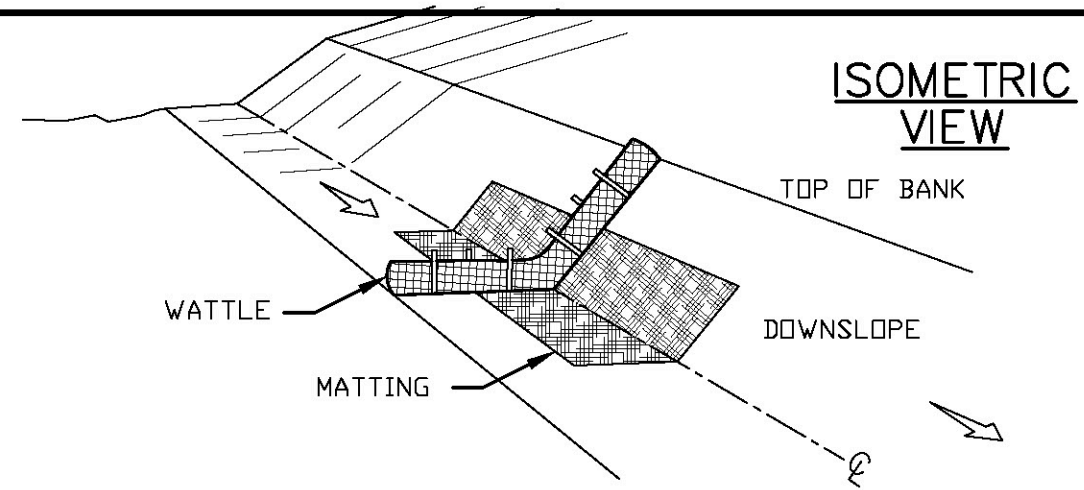

NOTES:

1. Use a minimum 12-inch diameter excelsior wattle.
2. Use 24-inch long wooden stakes with a 2"x2" nominal cross section.
3. Install wattle(s) to a height on slope so flow will not wash around wattle and scour slopes, or as directed.
4. Install a minimum of two upslope stakes and four downslope stakes at an angle to wedge wattle to ground at bottom of ditch.
5. Provide staples made of 0.125-inch diameter steel wire formed into a u-shape not less than 12 inches in length.
6. Install staples approximately every 1 linear foot on both sides of wattles and at each end to secure it to the soil.
7. After installation of staples, check any gaps between wattles and ground with matting.

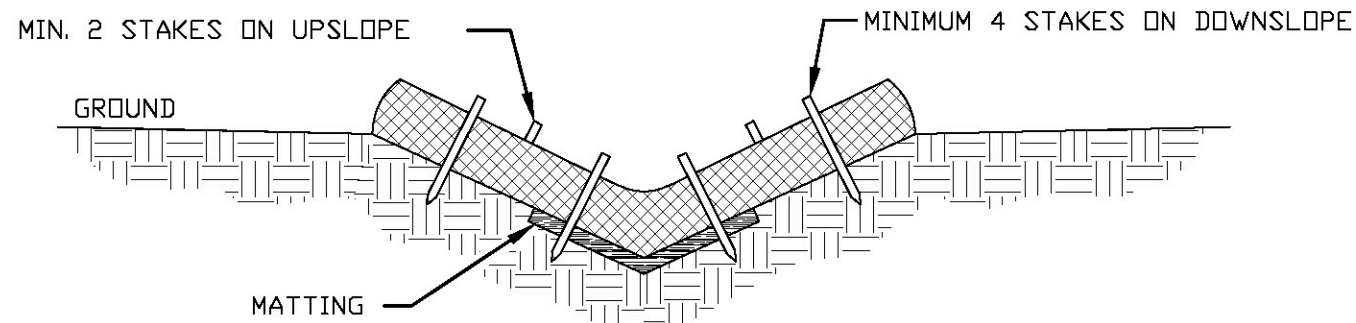

V-DITCH SECTION VIEW

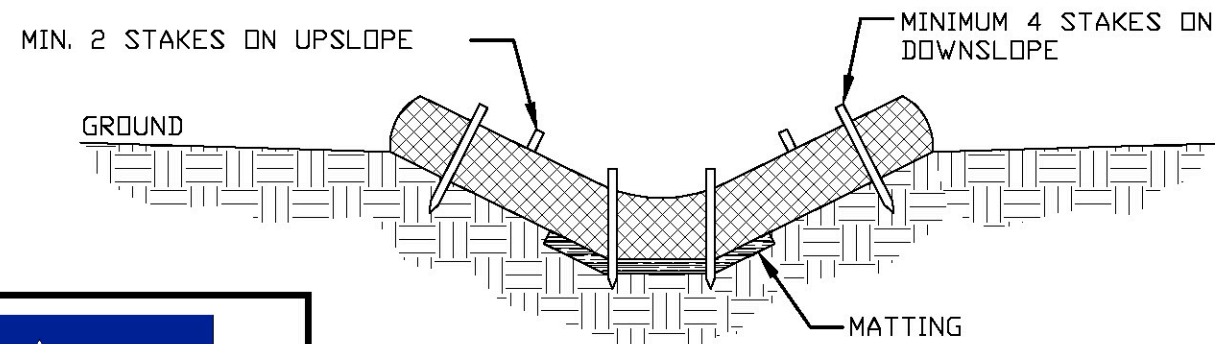

TRAPEZOIDAL DITCH SECTION VIEW

WEAVE STAPLES THROUGH MESH CASING OF WATTLE

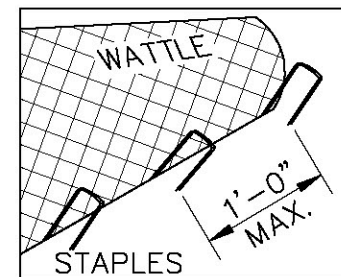

STAPLE INSTALLMENT SECTIONS

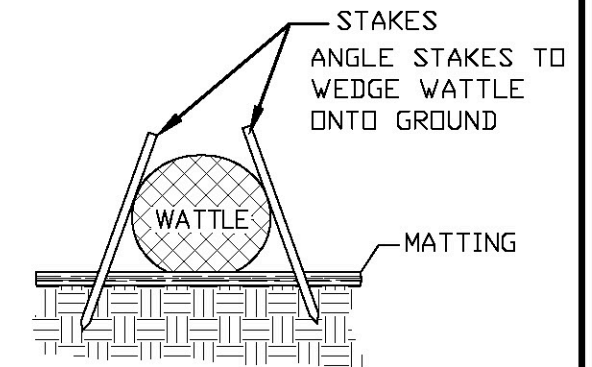
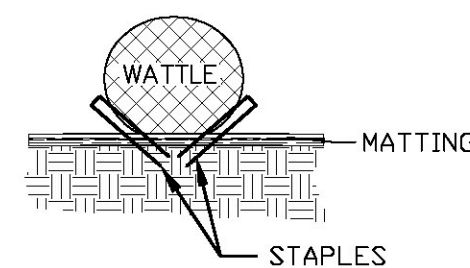

STAKE INSTALLMENT CROSS SECTION



EFFECTIVE: 4/15/19

STANDARD WATTLE DETAIL

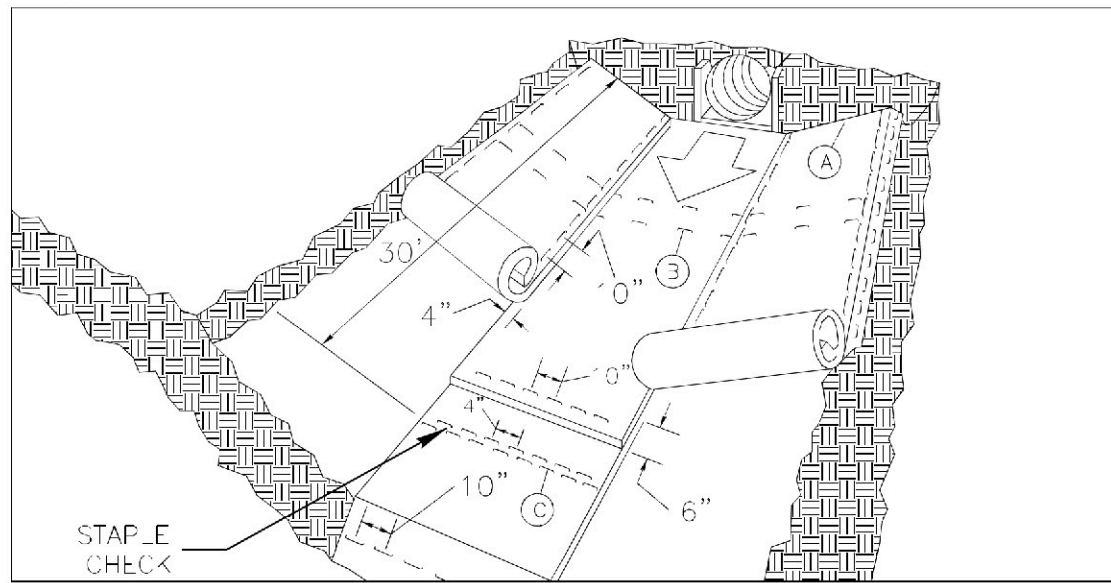

MATTING IN DITCHES

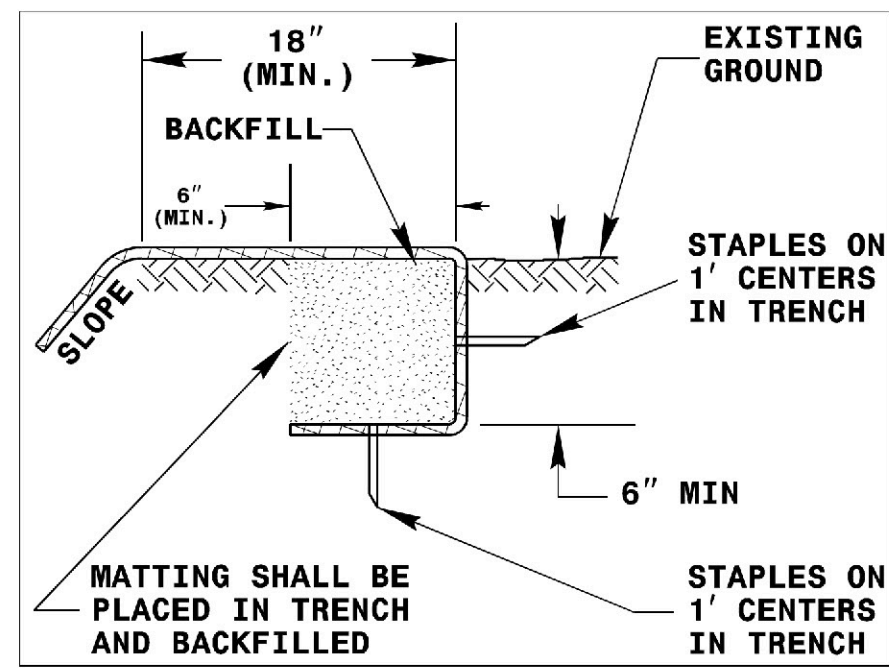
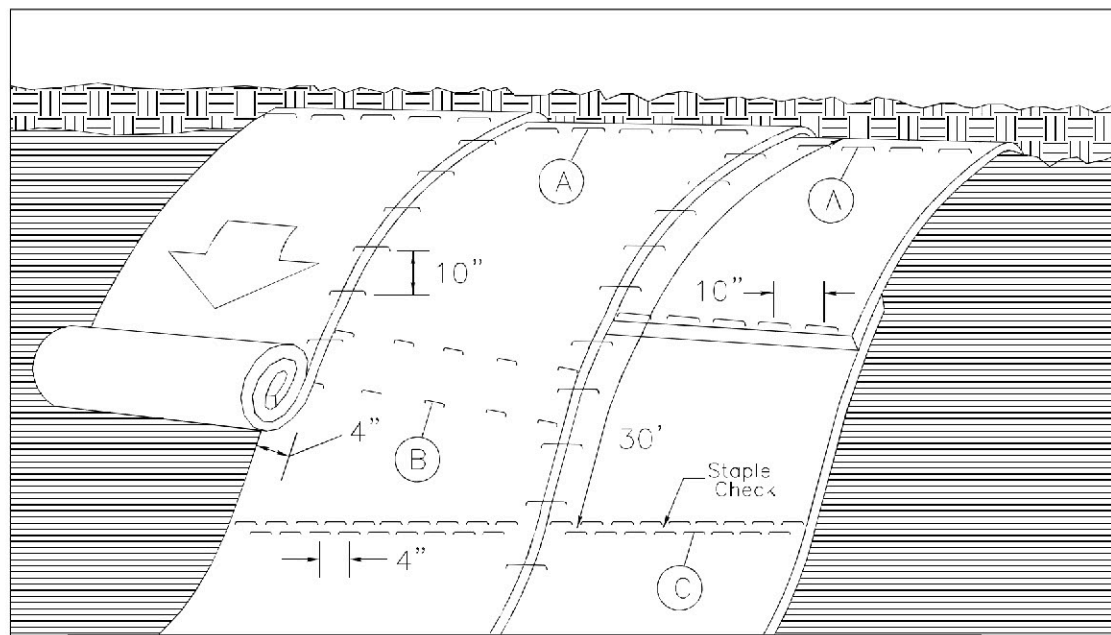

DIAGRAM (A)



MATTING ON SLOPES

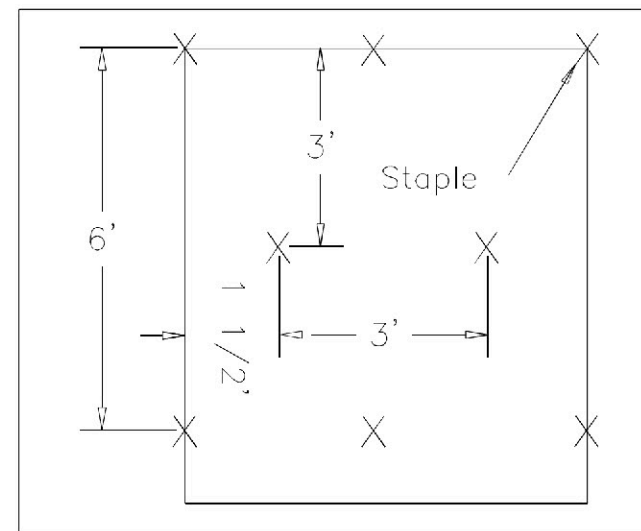

DIAGRAM (B)

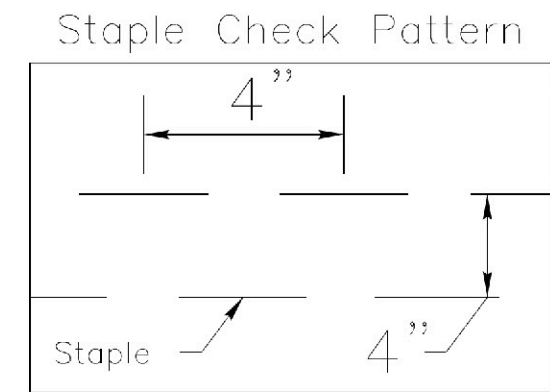
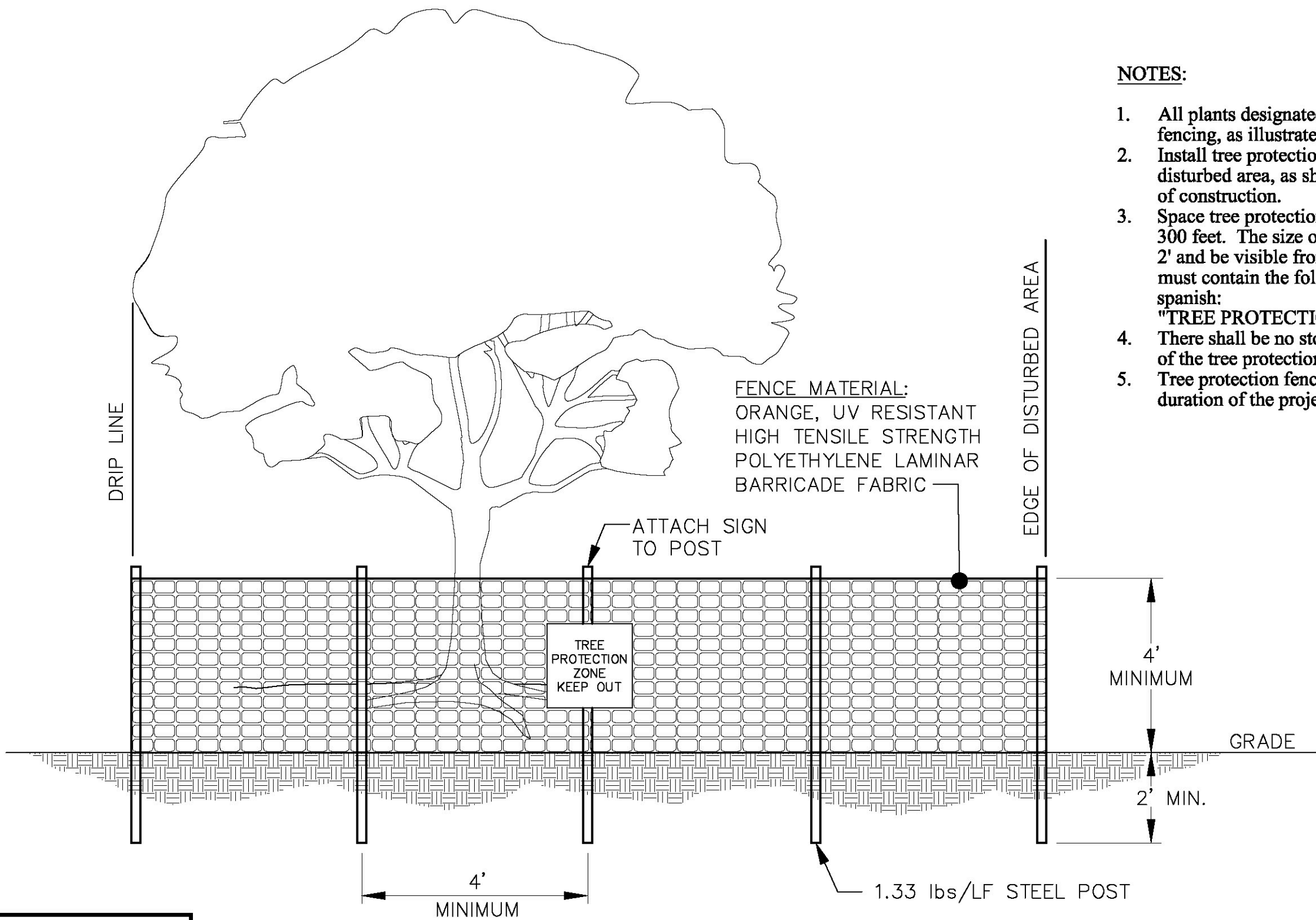

DIAGRAM (C)





NOTES:

1. All plants designated to be saved shall be protected by fencing, as illustrated.
2. Install tree protection fence at tree drip line or at edge of disturbed area, as shown on plans, prior to commencement of construction.
3. Space tree protection zone signs a minimum of one every 300 feet. The size of each sign must be a minimum of 2' x 2' and be visible from both sides of the fence. The sign must contain the following language in both english & spanish:
"TREE PROTECTION ZONE, KEEP OUT".
4. There shall be no storage of material within the boundaries of the tree protection fencing.
5. Tree protection fencing shall be maintained throughout the duration of the project.



STANDARD TREE PROTECTION FENCE DETAIL

A-11

EFFECTIVE: 4/15/19

GROUND STABILIZATION AND MATERIALS HANDLING PRACTICES FOR COMPLIANCE WITH THE NCG01 CONSTRUCTION GENERAL PERMIT

Implementing the details and specifications on this plan sheet will result in the construction activity being considered compliant with the Ground Stabilization and Materials Handling sections of the NCG01 Construction General Permit (Sections E and F, respectively). The permittee shall comply with the Erosion and Sediment Control plan approved by the delegated authority having jurisdiction. All details and specifications shown on this sheet may not apply depending on site conditions and the delegated authority having jurisdiction.

SECTION E: GROUND STABILIZATION

Required Ground Stabilization Timeframes		
Site Area Description	Stabilize within this many calendar days after ceasing land disturbance	Timeframe variations
(a) Perimeter dikes, swales, ditches, and perimeter slopes	7	None
(b) High Quality Water (HQW) Zones	7	None
(c) Slopes steeper than 3:1	7	If slopes are 10' or less in length and are not steeper than 2:1, 14 days are allowed
(d) Slopes 3:1 to 4:1	14	-7 days for slopes greater than 50' in length and with slopes steeper than 4:1 -7 days for perimeter dikes, swales, ditches, perimeter slopes and HQW Zones -10 days for Falls Lake Watershed
(e) Areas with slopes flatter than 4:1	14	-7 days for perimeter dikes, swales, ditches, perimeter slopes and HQW Zones -10 days for Falls Lake Watershed unless there is zero slope

Note: After the permanent cessation of construction activities, any areas with temporary ground stabilization shall be converted to permanent ground stabilization as soon as practicable but in no case longer than 90 calendar days after the last land disturbing activity. Temporary ground stabilization shall be maintained in a manner to render the surface stable against accelerated erosion until permanent ground stabilization is achieved.

GROUND STABILIZATION SPECIFICATION

Stabilize the ground sufficiently so that rain will not dislodge the soil. Use one of the techniques in the table below:

Temporary Stabilization	Permanent Stabilization
<ul style="list-style-type: none"> Temporary grass seed covered with straw or other mulches and tackifiers Hydroseeding Rolled erosion control products with or without temporary grass seed Appropriately applied straw or other mulch Plastic sheeting 	<ul style="list-style-type: none"> Permanent grass seed covered with straw or other mulches and tackifiers Geotextile fabrics such as permanent soil reinforcement matting Hydroseeding Shrubs or other permanent plantings covered with mulch Uniform and evenly distributed ground cover sufficient to restrain erosion Structural methods such as concrete, asphalt or retaining walls Rolled erosion control products with grass seed

POLYACRYLAMIDES (PAMS) AND FLOCCULANTS

- Select flocculants that are appropriate for the soils being exposed during construction, selecting from the *NC DWR List of Approved PAMS/Flocculants*.
- Apply flocculants at or before the inlets to Erosion and Sediment Control Measures.
- Apply flocculants at the concentrations specified in the *NC DWR List of Approved PAMS/Flocculants* and in accordance with the manufacturer's instructions.
- Provide ponding area for containment of treated Stormwater before discharging offsite.
- Store flocculants in leak-proof containers that are kept under storm-resistant cover or surrounded by secondary containment structures.

EQUIPMENT AND VEHICLE MAINTENANCE

- Maintain vehicles and equipment to prevent discharge of fluids.
- Provide drip pans under any stored equipment.
- Identify leaks and repair as soon as feasible, or remove leaking equipment from the project.
- Collect all spent fluids, store in separate containers and properly dispose as hazardous waste (recycle when possible).
- Remove leaking vehicles and construction equipment from service until the problem has been corrected.
- Bring used fuels, lubricants, coolants, hydraulic fluids and other petroleum products to a recycling or disposal center that handles these materials.

LITTER, BUILDING MATERIAL AND LAND CLEARING WASTE

- Never bury or burn waste. Place litter and debris in approved waste containers.
- Provide a sufficient number and size of waste containers (e.g dumpster, trash receptacle) on site to contain construction and domestic wastes.
- Locate waste containers at least 50 feet away from storm drain inlets and surface waters unless no other alternatives are reasonably available.
- Locate waste containers on areas that do not receive substantial amounts of runoff from upland areas and does not drain directly to a storm drain, stream or wetland.
- Cover waste containers at the end of each workday and before storm events or provide secondary containment. Repair or replace damaged waste containers.
- Anchor all lightweight items in waste containers during times of high winds.
- Empty waste containers as needed to prevent overflow. Clean up immediately if containers overflow.
- Dispose waste off-site at an approved disposal facility.
- On business days, clean up and dispose of waste in designated waste containers.

PAINT AND OTHER LIQUID WASTE

- Do not dump paint and other liquid waste into storm drains, streams or wetlands.
- Locate paint washouts at least 50 feet away from storm drain inlets and surface waters unless no other alternatives are reasonably available.
- Contain liquid wastes in a controlled area.
- Containment must be labeled, sized and placed appropriately for the needs of site.
- Prevent the discharge of soaps, solvents, detergents and other liquid wastes from construction sites.

PORTABLE TOILETS

- Install portable toilets on level ground, at least 50 feet away from storm drains, streams or wetlands unless there is no alternative reasonably available. If 50 foot offset is not attainable, provide relocation of portable toilet behind silt fence or place on a gravel pad and surround with sand bags.
- Provide staking or anchoring of portable toilets during periods of high winds or in high foot traffic areas.
- Monitor portable toilets for leaking and properly dispose of any leaked material. Utilize a licensed sanitary waste hauler to remove leaking portable toilets and replace with properly operating unit.

EARTHEN STOCKPILE MANAGEMENT

- Show stockpile locations on plans. Locate earthen-material stockpile areas at least 50 feet away from storm drain inlets, sediment basins, perimeter sediment controls and surface waters unless it can be shown no other alternatives are reasonably available.
- Protect stockpile with silt fence installed along toe of slope with a minimum offset of five feet from the toe of stockpile.
- Provide stable stone access point when feasible.
- Stabilize stockpile within the timeframes provided on this sheet and in accordance with the approved plan and any additional requirements. Soil stabilization is defined as vegetative, physical or chemical coverage techniques that will restrain accelerated erosion on disturbed soils for temporary or permanent control needs.

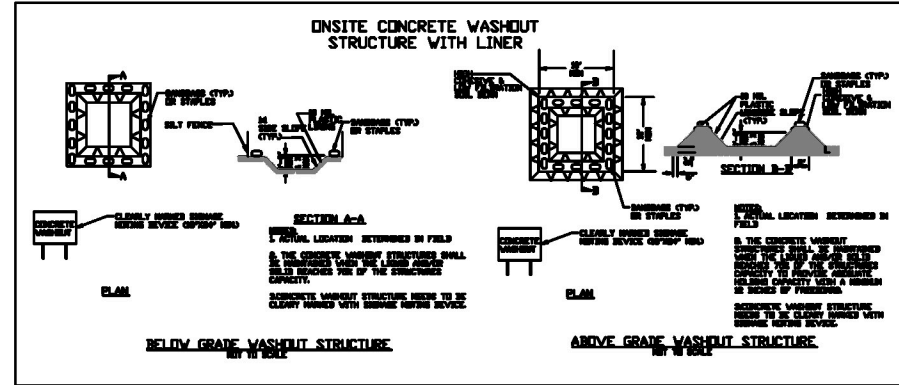

CONCRETE WASHOUTS

- Do not discharge concrete or cement slurry from the site.
- Dispose of, or recycle settled, hardened concrete residue in accordance with local and state solid waste regulations and at an approved facility.
- Manage washout from mortar mixers in accordance with the above item and in addition place the mixer and associated materials on impervious barrier and within lot perimeter silt fence.
- Install temporary concrete washouts per local requirements, where applicable. If an alternate method or product is to be used, contact your approval authority for review and approval. If local standard details are not available, use one of the two types of temporary concrete washouts provided on this detail.
- Do not use concrete washouts for dewatering or storing defective curb or sidewalk sections. Stormwater accumulated within the washout may not be pumped into or discharged to the storm drain system or receiving surface waters. Liquid waste must be pumped out and removed from project.
- Locate washouts at least 50 feet from storm drain inlets and surface waters unless it can be shown that no other alternatives are reasonably available. At a minimum, install protection of storm drain inlet(s) closest to the washout which could receive spills or overflow.
- Locate washouts in an easily accessible area, on level ground and install a stone entrance pad in front of the washout. Additional controls may be required by the approving authority.
- Install at least one sign directing concrete trucks to the washout within the project limits. Post signage on the washout itself to identify this location.
- Remove leavings from the washout when at approximately 75% capacity to limit overflow events. Replace the tarp, sand bags or other temporary structural components when no longer functional. When utilizing alternative or proprietary products, follow manufacturer's instructions.
- At the completion of the concrete work, remove remaining leavings and dispose of in an approved disposal facility. Fill pit, if applicable, and stabilize any disturbance caused by removal of washout.

HERBICIDES, PESTICIDES AND RODENTICIDES

- Store and apply herbicides, pesticides and rodenticides in accordance with label restrictions.
- Store herbicides, pesticides and rodenticides in their original containers with the label, which lists directions for use, ingredients and first aid steps in case of accidental poisoning.
- Do not store herbicides, pesticides and rodenticides in areas where flooding is possible or where they may spill or leak into wells, stormwater drains, ground water or surface water. If a spill occurs, clean area immediately.
- Do not stockpile these materials onsite.

HAZARDOUS AND TOXIC WASTE

- Create designated hazardous waste collection areas on-site.
- Place hazardous waste containers under cover or in secondary containment.
- Do not store hazardous chemicals, drums or bagged materials directly on the ground.



For questions and assistance, please contact NCDEQ at 919-707-3639.

**PART III
SELF-INSPECTION, RECORDKEEPING AND REPORTING**

SECTION A: SELF-INSPECTION

Self-inspections are required during normal business hours in accordance with the table below. When adverse weather or site conditions would cause the safety of the inspection personnel to be in jeopardy, the inspection may be delayed until the next business day on which it is safe to perform the inspection. In addition, when a storm event of equal to or greater than 1.0 inch occurs outside of normal business hours, the self-inspection shall be performed upon the commencement of the next business day. Any time when inspections were delayed shall be noted in the Inspection Record.

Inspect	Frequency (during normal business hours)	Inspection records must include:
(1) Rain gauge maintained in good working order	Daily	Daily rainfall amounts. If no daily rain gauge observations are made during weekend or holiday periods, and no individual-day rainfall information is available, record the cumulative rain measurement for those unattended days (and this will determine if a site inspection is needed). Days on which no rainfall occurred shall be recorded as "zero." The permittee may use another rain-monitoring device approved by the Division.
(2) E&SC Measures	At least once per 7 calendar days and within 24 hours of a rain event \geq 1.0 inch in 24 hours	1. Identification of the measures inspected, 2. Date and time of the inspection, 3. Name of the person performing the inspection, 4. Indication of whether the measures were operating properly, 5. Description of maintenance needs for the measure, 6. Description, evidence, and date of corrective actions taken.
(3) Stormwater discharge outfalls (SDOs)	At least once per 7 calendar days and within 24 hours of a rain event \geq 1.0 inch in 24 hours	1. Identification of the discharge outfalls inspected, 2. Date and time of the inspection, 3. Name of the person performing the inspection, 4. Evidence of indicators of stormwater pollution such as oil sheen, floating or suspended solids or discoloration, 5. Indication of visible sediment leaving the site, 6. Description, evidence, and date of corrective actions taken.
(4) Perimeter of site	At least once per 7 calendar days and within 24 hours of a rain event \geq 1.0 inch in 24 hours	If visible sedimentation is found outside site limits, then a record of the following shall be made: 1. Actions taken to clean up or stabilize the sediment that has left the site limits, 2. Description, evidence, and date of corrective actions taken, and 3. An explanation as to the actions taken to control future releases.
(5) Streams or wetlands onsite or offsite (where accessible)	At least once per 7 calendar days and within 24 hours of a rain event \geq 1.0 inch in 24 hours	If the stream or wetland has increased visible sedimentation or a stream has visible increased turbidity from the construction activity, then a record of the following shall be made: 1. Description, evidence and date of corrective actions taken, and 2. Records of the required reports to the appropriate Division Regional Office per Part III, Section C, Item (2)(a) of this permit of this permit.
(6) Ground stabilization measures	After each phase of grading	1. The phase of grading (installation of perimeter E&SC measures, clearing and grubbing, installation of storm drainage facilities, completion of all land-disturbing activity, construction or redevelopment, permanent ground cover). 2. Documentation that the required ground stabilization measures have been provided within the required timeframe or an assurance that they will be provided as soon as possible.

NOTE: The rain inspection resets the required 7 calendar day inspection requirement.

**PART III
SELF-INSPECTION, RECORDKEEPING AND REPORTING**

SECTION B: RECORDKEEPING

1. E&SC Plan Documentation

The approved E&SC plan as well as any approved deviation shall be kept on the site. The approved E&SC plan must be kept up-to-date throughout the coverage under this permit. The following items pertaining to the E&SC plan shall be documented in the manner described:

Item to Document	Documentation Requirements
(a) Each E&SC Measure has been installed and does not significantly deviate from the locations, dimensions and relative elevations shown on the approved E&SC Plan.	Initial and date each E&SC Measure on a copy of the approved E&SC Plan or complete, date and sign an inspection report that lists each E&SC Measure shown on the approved E&SC Plan. This documentation is required upon the initial installation of the E&SC Measures or if the E&SC Measures are modified after initial installation.
(b) A phase of grading has been completed.	Initial and date a copy of the approved E&SC Plan or complete, date and sign an inspection report to indicate completion of the construction phase.
(c) Ground cover is located and installed in accordance with the approved E&SC Plan.	Initial and date a copy of the approved E&SC Plan or complete, date and sign an inspection report to indicate compliance with approved ground cover specifications.
(d) The maintenance and repair requirements for all E&SC Measures have been performed.	Complete, date and sign an inspection report.
(e) Corrective actions have been taken to E&SC Measures.	Initial and date a copy of the approved E&SC Plan or complete, date and sign an inspection report to indicate the completion of the corrective action.

2. Additional Documentation

In addition to the E&SC Plan documents above, the following items shall be kept on the site and available for agency inspectors at all times during normal business hours, unless the Division provides a site-specific exemption based on unique site conditions that make this requirement not practical:

- This general permit as well as the certificate of coverage, after it is received.
- Records of inspections made during the previous 30 days. The permittee shall record the required observations on the Inspection Record Form provided by the Division or a similar inspection form that includes all the required elements. Use of electronically-available records in lieu of the required paper copies will be allowed if shown to provide equal access and utility as the hard-copy records.
- All data used to complete the Notice of Intent and older inspection records shall be maintained for a period of three years after project completion and made available upon request. [40 CFR 122.41]

**PART III
SELF-INSPECTION, RECORDKEEPING AND REPORTING**

SECTION C: REPORTING

1. Occurrences that must be reported

Permittees shall report the following occurrences:

- Visible sediment deposition in a stream or wetland.
- Oil spills if:
 - They are 25 gallons or more,
 - They are less than 25 gallons but cannot be cleaned up within 24 hours,
 - They cause sheen on surface waters (regardless of volume), or
 - They are within 100 feet of surface waters (regardless of volume).
- Releases of hazardous substances in excess of reportable quantities under Section 311 of the Clean Water Act (Ref: 40 CFR 110.3 and 40 CFR 117.3) or Section 102 of CERCLA (Ref: 40 CFR 302.4) or G.S. 143-215.85.
- Anticipated bypasses and unanticipated bypasses.
- Noncompliance with the conditions of this permit that may endanger health or the environment.

2. Reporting Timeframes and Other Requirements

After a permittee becomes aware of an occurrence that must be reported, he shall contact the appropriate Division regional office within the timeframes and in accordance with the other requirements listed below. Occurrences outside normal business hours may also be reported to the Division's Emergency Response personnel at (800) 662-7956, (800) 858-0368 or (919) 733-3300.

Occurrence	Reporting Timeframes (After Discovery) and Other Requirements
(a) Visible sediment deposition in a stream or wetland	<ul style="list-style-type: none"> Within 24 hours, an oral or electronic notification. Within 7 calendar days, a report that contains a description of the sediment and actions taken to address the cause of the deposition. Division staff may waive the requirement for a written report on a case-by-case basis. If the stream is named on the NC 303(d) list as impaired for sediment-related causes, the permittee may be required to perform additional monitoring, inspections or apply more stringent practices if staff determine that additional requirements are needed to assure compliance with the federal or state impaired-waters conditions.
(b) Oil spills and release of hazardous substances per Item 1(b)-(c) above	<ul style="list-style-type: none"> Within 24 hours, an oral or electronic notification. The notification shall include information about the date, time, nature, volume and location of the spill or release.
(c) Anticipated bypasses [40 CFR 122.41(m)(3)]	<ul style="list-style-type: none"> A report at least ten days before the date of the bypass, if possible. The report shall include an evaluation of the anticipated quality and effect of the bypass.
(d) Unanticipated bypasses [40 CFR 122.41(m)(3)]	<ul style="list-style-type: none"> Within 24 hours, an oral or electronic notification. Within 7 calendar days, a report that includes an evaluation of the quality and effect of the bypass.
(e) Noncompliance with the conditions of this permit that may endanger health or the environment [40 CFR 122.41(l)(7)]	<ul style="list-style-type: none"> Within 24 hours, an oral or electronic notification. Within 7 calendar days, a report that contains a description of the noncompliance, and its causes; the period of noncompliance, including exact dates and times, and if the noncompliance has not been corrected, the anticipated time noncompliance is expected to continue; and steps taken or planned to reduce, eliminate, and prevent reoccurrence of the noncompliance. [40 CFR 122.41(l)(6). Division staff may waive the requirement for a written report on a case-by-case basis.



For questions and assistance, please contact NCDEQ at 919-707-3639.

Temporary seeding recommendations for late Winter/Early Spring

Seeding Mixture

Species	Rate (Lb/acre)
Rye (green)	120
Annual lespedeza (Kobe in Piedmont and Costal Plain, Korean in Mountains)	50

Omit annual lespedeza when duration of temporary cover is not to extend beyond June.

Seeding dates:

Mountains- Above 2,500 feet: Feb 15- may 15
Below 2,500 feet: Feb 1-May 1

Soil Amendments:

Follow recommendations of soil tests or apply 2 ton/acre ground agricultural limestone and 1,000 lb/acre 10-10-10 fertilizer.

Mulch:

Apply 4,000/lb/acre straw. Anchor straw by asphalt tack, netting or a mulch anchoring tool. A disk with blades set nearly straight can be used as a mulching anchoring tool.

Maintenance:

Re-fertilize if growth is not fully adequate. Reseed, re-fertilize and mulch immediately following erosion and other damage.

Temporary seeding recommendations for Summer

Seeding Mixture

Species	Rate (Lb/acre)
German millet	40

Seeding dates:

Mountains- May 15-Aug 15
Piedmont- May 1 -Aug 1
Costal Plain- April 15- Aug 15

Soil Amendments:

Follow recommendations of soil tests or apply 2 ton/acre ground agricultural limestone and 1,000 lb/acre 10-10-10 fertilizer.

Mulch:

Apply 4,000/lb/acre straw. Anchor straw by asphalt tack, netting or a mulch anchoring tool. A disk with blades set nearly straight can be used as a mulching anchoring tool.

Maintenance:

Re-fertilize if growth is not fully adequate. Reseed, re-fertilize and mulch immediately following erosion and other damage.

Temporary seeding recommendations for Fall

Seeding Mixture

Species	Rate (Lb/acre)
Rye	120

Seeding dates:

Mountains- Aug 15 - Dec 15
Piedmont- Aug 15 - Dec 30
Costal Plain- Aug 15 - Dec 15

Soil Amendments:

Follow recommendations of soil tests or apply 2 ton/acre ground agricultural limestone and 1,000 lb/acre 10-10-10 fertilizer.

Mulch:

Apply 4,000/lb/acre straw. Anchor straw by asphalt tack, netting or a mulch anchoring tool. A disk with blades set nearly straight can be used as a mulching anchoring tool.

Maintenance:

Repair and maintain damaged areas immediately. Topdress with 50 lb/acre of nitrogen in March. If it is necessary to extend temporary cover beyond June 15, overseed with 50 lb/acre Kobe (Piedmont and Costal Plain) or Korean (Mountains) lespedeza in late February or early March.

PERMANENT SEEDING REQUIREMENTS FOR SHOULDERS, SIDE DITCHES, SLOPES (MAX. 3:1)

Date	Type	Planting Rate
Aug 15 - Nov 1	Tall Fescue	300 lbs/acre
Nov 1 - Mar 1	Tall Fescue & Abruzzi Rye	300 lbs/acre
Mar 1 - Apr 15	Tall Fescue	300 lbs/acre
Apr 15 - Jun 30	Hulled Common Bermudagrass	25 lbs/acre
Jul 1 - Aug 15	Tall Fescue AND Browntop Millet or Sorghum-Sudan Hybrids***	125 lbs/acre (Tall Fescue); 35 lbs/acre Browntop Millet); 30 lbs/acre (Sorghum-Sudan Hybrids)



EFFECTIVE: 4/15/19

SEEDING REQUIREMENTS

NOTES:

1. Construction details provided in this standard plan are NOT drawn to scale.
2. These details are for lots with less than one acre of land disturbance.
3. If the land disturbance on a single lot is greater than one acre, a custom plan should be submitted for the 30-day review cycle that addresses berms/diversions and sediment storage traps and basins.
4. This document is a guideline to control sediment onsite for single family lots with a disturbed area of less than one acre. Additional sediment control measures may be needed on a site-by-site basis.
5. Additional information on specification and installation guidelines can be obtained from the State Erosion and Sedimentation Control Design Manual.

<https://deq.nc.gov/about/divisions/energy-mineral-land-resources/erosion-sediment-control>

REFERENCES:

City of Raleigh, Stormwater, Standard Details

<https://www.raleighnc.gov/business/content/PlanDev/Articles/DevServ/DrawingsStandardDetailsIndex.html>

Delaware Erosion and Sediment Control Handbook

NCDEQ, Division of Mineral and Land Resources, Mooresville Regional Office, Typical Lot by Lot Sediment and Erosion Control Plan.

NCDEQ Sediment and Erosion Control Design Manual, May 2013.

<https://deq.nc.gov/about/divisions/energy-mineral-land-resources/energy-mineral-land-permit-guidance/erosion-sediment-control-planning-design-manual>

Town of Cary, Standard Detail Drawings

<https://www.townofcary.org/business-development/developing-in-cary/standard-detail-drawings-2017>

Wake County, Sediment Control Details

<http://www.wakegov.com/water/stormwater/erosion/Pages/erosionspecs.a`spx>

The Nau Company, Standard Single Lot Erosion Control Template

www.thenauco.com

NCDOT, Roadside Environmental Unit, 2018 Roadway Standard Drawings, Division 16 Erosion Control and Roadside Development

